

Claribel Beutler 23 Feb 77.
Weidman Route 2A
Main Street, Weidman

The Weidman Messenger

VOL. XIV, NO. 38

Weidman, Mich. 48893

Thursday, April 13, 1978

35¢ per copy

Editor's Column

By Connie

YUP, I HAD A WONDERFUL, RESTFUL VACATION

So yup, I had just a wonderful vacation during the weekend of March and the first week of April.

I sure rested--and I needed it, too. Some folks try to hide snickers when I tell 'em I became exhausted during my Christmas vacation because my Sadie cat cried in a agony seven days and nights before the poor thing could finally die.

I was plumb wore out, as we say out here in the sticks. (And it's a good, descriptive expression, too, and needs no apologies by anyone.)

Anyhow, during my spring break I was privileged to see that blasted snow melt away; the crocus pop up and bloom, even though it was iced over a couple of times. It just went on blooming.

And the snow went!

I think all of us had one of the worst winters of our lives, because winter really began in November and fiercely continued on through March.

That's a long time to gaze at those horrid snowbanks.

But they're gone now; and while we'll undoubtedly have some cold snaps between now and garden-planting time, still we don't have to look at those 10-foot-high snowdrifts all over the landscape.

Now, of course, there's a pile of cleanup to be done, on lawns and gardens and such.

What the heck, though! We did get rid of those nasty piles of snow we lived with for so long!

Incidentally, my rhubarb has been showing little red tips peeping up from the ground, and if it would just stay warm a few days, I'd have myself a rhubarb pie from my own place; which is half the enjoyment of eating.

---0---

Mrs. Forrest Johnston was a dinner guest Sunday at the home of her mother, Mrs. Claribel Beutler. They attended the opening of the museum of history and cultural area at Warriner Hall on the campus at Mt. Pleasant.



YEP, WE'LL BE HAVING WEIDMAN DAY--Again this year! And it's called the Centennial Weidman Day, as monies realized from various entertainments and eating facilities will be used to finance Weidman's Centennial at a future time. The above photo is of the first revival of Weidman Day, in 1976, the country's Bicentennial.

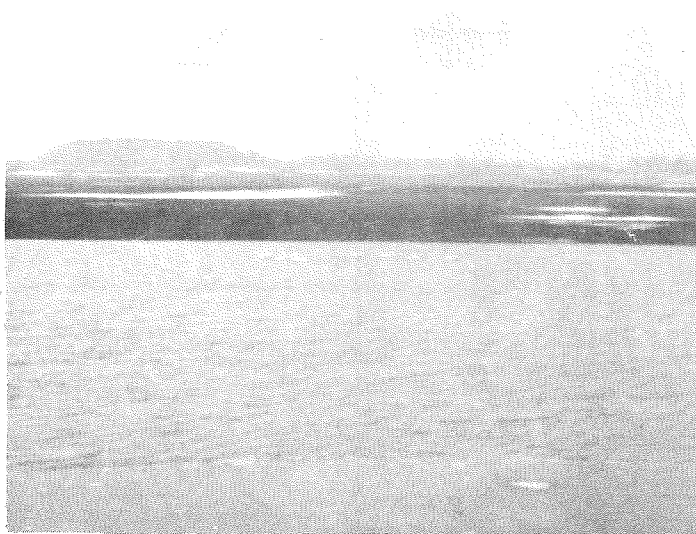

LOOK CLOSELY--And you may see nine beautiful white swans as they rested on a large farm pond on the Vogel acres along Vernon Road, late last week. Ye Ed stood on the roadway, but the birds thought that was too close, and presently took off in a nor'west direction. Area lakes were still frozen over, and the swans choose farm ponds where they can find them.

FIREMEN'S ANNUAL AUCTION SET FOR APRIL 29

The annual auction sale sponsored by the Nottawa and Sherman Volunteer Fire Department is scheduled for Saturday night, April 29.

Donations are solicited--everything from garden tractors to household appliances and knickknacks. Everything but used clothing is desired.

Especially needed is baked goods, which always is a most popular feature, and always short of supply.

For pickup of items too large to tote to the Village Inn Tavern, where the auction will be held, the following phone numbers are available:

(All on Weidman exchange).
644-3507, 644-3501, 644-2147,
Or 644-3640. All of these numbers are Firemen's homes, and they will arrange for pickup.

Have a good time April 29!

---0---

Baumann's IGA Jet Journey to the Stars is on, at both stores, Weidman and Rosebush.

WEIDMAN DAY PLANS DISCUSSED AT MEETING

At a meeting of interested citizens held the last Thursday in March, plans were discussed for this year's annual celebration.

The meeting was called to order by Bud Fredrickson, president of the Weidman Day Committee sponsored by the Weidman Business Association.

Present were Spike and Pauline Branson, Ed Fox, Ed Ley, Evelyn Hackney, Walt and Jeanne Smith, Thayne and Phyllis Sides, Russ Braman, Dick Curtiss, and Bud and Jennie Fredrickson.

New officers to be in charge of plans for celebration day included Bud Fredrickson, Ed Fox and Russ Braman.

A number of committee heads were appointed.

It was decided to cut expenses over last year and attempt to net more money for the long-range planning of Weidman's Centennial.

Several changes were planned for this summer's Weidman Day:

Entertainment additions such as possibly a flea market, and a tractor-pulling contest, among

others.

The celebration will begin Friday evening and continue on through Saturday and Saturday evening.

---0---

West Gilmore

Lena Cole, Reporter

Mr. and Mrs. Ralph Bawkey of Muskegon visited his aunt, Mrs. Anna Hanner, at Pleasant Manor in Mt. Pleasant, last Tuesday. I was with them, and we also visited Della Bricker Green, and Jessie Palmer. We enjoyed a very nice visit with each of them.

The Bawkeys were dinner guests of their cousins, the Paul Coles, last Tuesday.

Mr. and Mrs. Tony Masiwchuk went to Irons near Ludington Sunday. The Masiwchuks went to Detroit Tuesday, and spent two days with their daughter, Debbie.

Mr. and Mrs. Richard Pfannes visited his brother and sister-in-law, Mr. and Mrs. Bess Pfannes, Thursday.

Those who helped Mrs. Orma Kripa celebrate her birthday Saturday evening were Mr. and Mrs.

Sebastian Pfannes, the Paul Coles and Velma, Mrs. Clara Mossell and Johnny, and Dick Mossell.

Barbara Dennis and Rusty and Robin and Dan Kripa and Willie were also guests at the party. It was held at the home of Mr. and Mrs. Richard Mahon. A lovely supper was enjoyed by all.

Mrs. Clara Mossell and son, Johnny, and brother-in-law, Richard Mossell, of South Bend, Ind., spent the weekend with their grandparents, the Paul Coles. They also called on their uncle and aunt, Mr. and Mrs. Charles Merchant, of Harrison.

Sunday dinner guests of the Paul Coles were Paul's niece and nephew, Mr. and Mrs. Robert Myers and Mark, Bonnie and Sarah,

and Mr. and Mrs. Mark Loomis, all of Bath.

---0---

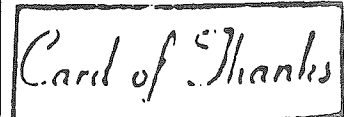

I would like to thank everyone who sent cards during my stay in the hospital, and afterward. Your thoughtfulness is much appreciated.

As ever,
Jean Vore

One year ago today the high temperature was 70 and the low, 37.

SCHAFFER'S BAIT & SPORTING GOODS

Livebait...Camping Supplies Hunting and Fishing Licenses
Tackle...Guns and Ammunition
Open 7 Days a Week 7 a.m. to 7 p.m.
Weidman, Mich. Ph. 644-3501

Hardware
And
Furniture
Items



Appliances
Auto Parts
Bikes & Parts
Garden Tractors
Lawn Mowers

WHITEY McCREIGHT AND BENN JOHNSON

WEIDMAN

Phone 644-3640

**WEIDMAN DISCOUNT STORE
COLDWATER ROAD**

WEIDMAN

FURNITURE--GLASSWARE--GIFTS AND TOYS
Compare Our Prices Before You Buy

Tel. 644-2712

BILL AND LOU ANN MAEDER

FOX HARDWARE

PAINT GLASS APPLIANCES SPORTING GOODS

WEIDMAN

We Service What We Sell

PHONE 644-3631

Daggett
Funeral Home
BARRYTON



Phone 382-5566

**LIVESTOCK & GRAIN TRUCKING
ROBERT BLEISE**

WEIDMAN

Ph. 644-3516

DICK

CURTISS

JENKINS OIL COMPANY

DISTRIBUTOR OF OIL PRODUCTS

Office 5th Street, Weidman Phone 644-3346
WHOLESALE...RETAIL

**VIC'S
SERVICE STATION**

TIRES--BATTERIES--ACCESSORIES
BOTTLE GAS

Weidman

Phone 644-2200

**RAU'S FOODLAND
BEAL CITY**

QUALITY FOODS
BEER AND WINE TAKEOUT

Dial 644-2243

**BAUMANN'S
FOODLINER**



STORE HOURS:
Mon., Tues., Wed. 9-6
Thurs. & Sat. 9-7
Friday 9-9, Sunday 9-1.

HERMAN'S GARAGE

Beal City

Phone 644-3645

OUR SPECIALTIES: Motor Tune-Up MOBIL GAS AND OIL
Wheel Alignment, Auto Repair

Weidman Messenger

Weidman, Michigan

EDITOR AND PUBLISHER: Constance Skinner.

Tel. 644-2000, Weidman. Address, 6298 Airline Road, Weidman, Mich. 48893.

SUBSCRIPTION RATES: \$8 per year locally. Anywhere in the world, \$11.00. Single copy 35¢.

Second-class Postage paid at Weidman, Michigan.

Published at Weidman, Isabella County, Michigan, each Thursday; except that the last week of June and the first week of July; the last week of September and the first week of October; the last week of March and the first week of April, and the Christmas and New Year's editions are combined.

Address all mail: Weidman Messenger, Weidman, Michigan 48893.

Want Ads

WANT AD RATES: 75 cents per week, unless very long. Over 1 inch in length, regular advertising rates. Cards of Thanks \$2.50, unless very long.

WANTED--Building and remodeling jobs. 10 years' experience. Free estimates. No job too small. Ph. Richard's Building and Remodeling, 644-2643.

Mar10tf

PIANO TUNING--And service. Russell Merrihew, West Broomfield Road, PO Remus 39340, ph. (Blanchard) 561-2592. Pd. to Feb. 1, 1978

GARAGE SALE--April 13-14-15, 9 a.m. till dark, 3/4 mi. west of Weidman on Airline Road, at Walt Smith's. Apr13t1p

FOR SALE--Pink formal, green-flowered formal, both size 11. Ph. 644-3588. Please call in the mornings. Mrs. Edwardine Pung.

Apr13t1

Card of Thanks

I wish to thank everyone for their cards and flowers while I was in the hospital.
Sadie Zorn

CATHOLICS TO HEAR DISTINGUISHED SPEAKER

Fr. Vincent Miceli, S.J., will be the speaker on the subject of "Signs of the Antichrist", at the Holy Trinity gym, 1000 South Wenona in Bay City Sunday, April 16, at 8 p.m.

He is sponsored by Catholics United for the Faith, Inc., and many from this area are expected to be interested in hearing and seeing him.

Thelma Simmer has tickets for the lecture, and also can provide rides for those needing them. Her phone number is 644-2015.

Fr. Miceli is an international-

ly known journalist, author of two books on the Catholic religion, and is nationally known on radio and television.

The public, Catholic and Protestants alike, are invited to

AREA BINGO

B-I-N-G-O

WEIDMAN BUSINESS ASSOCIATION

1/2 MILE SOUTH OF WEIDMAN On Coldwater Road Every Wednesday Night, 6.30 p.m. till 11 p.m.

Feb. 10, 79p

B-I-N-G-O

Joint Temple Association 413 Coker Drive Every Saturday Night 6:30 P.M.

9 Aug. 78p

Card of Thanks

The family of Glenn Frantz wish to express our thanks to relatives, friends and neighbors for their thoughts and acts of kindness during the illness and death of our father.

Thanks to Dr. S. Velena, M. D., and staff at the Reed City Hospital for their care and thoughtfulness. A special thanks to the Weidman Fire Department.

Thanks to the Daggett Funeral Home, Rev. Larry Pitts for his comforting words.

Your help will always be in our hearts.

Glenn D. and Fern Frantz And Family
Arlyn and Gloria Frantz
Donelda and Al Costello And Family
Neita and Harvey Blackmer And Family

the lecture by this reknowned author-speaker.

---0---

Mr. and Mrs. Gerald Middlesworth returned home Friday after spending two weeks with Jack and Gertie Middlesworth at Leesburg, Florida.

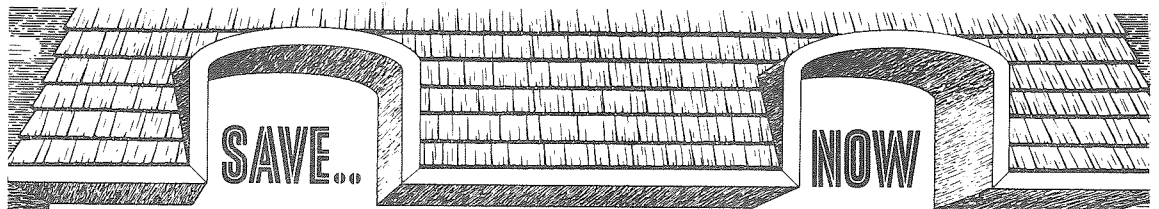

IT'S HOME IMPROVEMENT TIME

We're ready. . .Are you?

Isabella Bank & Trust has Home Improvement *Money* for you for Fireplaces, Garages, Insulation and Siding (to lower your heat costs next winter), Family Rooms, Kitchens, Landscaping, Bathrooms, Wiring, Driveways and much, much more. **ARE YOU READY?**

10.5%

ANNUAL INTEREST RATE

Now you can borrow up to \$10,000 for up to 10 Years at an annual percentage rate of only 10.5%. Stop in and see our Friendly Home Improvement Loan Officers and start your project soon.



isabella bank and trust

Your Hometown Friend

MEMBER F.D.I.C.





Brinton News

Frances Beck, Reporter

Mr. and Mrs. Clifford Chase of near Marion called on their uncle, Tony Bartley, Sunday.

Mr. and Mrs. Lyle Cook had her sister, Gay, as a week's guest.

Barbara Irish of Lake Thirteen called on her son, Richard, and wife, Thursday.

Helen Strang and her mother, Eunice La Londe, were in Mt. Pleasant Thursday, where Eunice called on her doctor.

Irene Bowen was a patient in CMC Hospital last week, going in Tuesday and returning home

Sunday.

Mr. and Mrs. George Beers spent last week with their daughter, Diana, and family at Traverse City.

Helen Strang and family and Eunice La Londe called on Mr. and Mrs. Gary La Londe Sunday.

Ruth Teeter and family of Clare called on Edna Teeter Sunday.

Jane Tower arrived home last week Monday from the Lakeview Hospital, where she had been a patient.

I attended a pre-nuptial wedding shower for Karen Buchel Sunday afternoon, at her future home near Mt. Pleasant.

NEWS NOTES

Mr. and Mrs. Emil Phillips were in Clare last Wednesday. They and Mr. and Mrs. Lloy Sperry went to Omer and watched the sucker-dipping, on the Au Gres River, Saturday.

Tyson Sanford, formerly working as a plumber with the Klein company in Mt. Pleasant, is now working as foreman of installations at the nuclear power plant (Consumers Power) at Midland. He's foreman of the pipe-fitters and welders, with Union Local 85 out of Saginaw.

Two years ago today high temp. was 60 and the low, 40.



DR. JOHN L. KNIGHT
Evangelist

Dr. John L. Knight will be the evangelist for revival services at the Weidman Church of the Nazarene April 27 through May 7, beginning at 7 o'clock each evening, and on Sundays at 11 a. m. and 7 p. m.

Richard Wadsworth, pastor of the local church, is proud to announce the appearance of this distinguished evangelist.

The public is cordially invited to attend any or all services.

---0---



REV. DAVID MALTZAN

The Gilmore Church of Christ on West Coleman Road has announced the arrival of its new minister and his family, who come from Casey Creek, Kentucky.

The David Maltzan family consists of Dave, his wife Judy, and children Dawn, Tim and Amy, who have settled into their new home beside the church.

Rev. Maltzan is a graduate of Johnson Bible College at Knoxville, Tenn., and has a BA degree. He has served in the U. S. Air Force.

Services at the Gilmore church are always open to visitors. Sunday morning worship is at 9.30, Bible School for all ages at 10.30, and evening worship at 7 p. m.

Ladies' Wednesday morning Bible Study class is at 10, and the Family Bible Study is Thursdays at 7 p. m.

ATTENTION FARMERS

Consignment Auction Sale

Sponsored By The Beal City
Businessmen's Association

To Be Held May 20th, 1978 at
11:00 a.m. At The Beal City Centennial
Park Which All Proceeds Will Be
Used For.

Please Contact Any Of The Businessmen Listed

Below For Details And Listing Of Equipment.

Beal City Office Of American Security Bank 644-3357

Keith Schumacher 644-2057

Rau's Boron Service 644-2142

Tilmann's Hardware 644-2252

Weber Brothers Sawmill 644-2206

Beal City

Dora Smith, Reporter

Louise Schafer went to Grand Rapids Sunday to visit Sr. Margaret Schafer.

Joyce Schafer was in Saginaw last Tuesday, shopping.

Mary Ellen Simon of Weidman called on Louise Schafer Friday.

Mr. and Mrs. Ed Schafer called on Tillie Schafer Thursday evening. Mr. and Mrs. Milo Eldred of Winn were Friday evening visitors. Mr. and Mrs. Whitney and Mr. and Mrs. Jerry Joe Schafer of Mt. Pleasant were Wednesday evening callers.

Tillie and Louise Schafer spent Sunday at the Oscar Schafer home.

Mr. and Mrs. Bernard Rau and Mr. and Mrs. Fred Steffke and Mr. and Mrs. Herman Grinzinger attended the wedding of Samuel and Mary Ann Orkis in Saginaw Friday evening.

The family of Herman Grinzinger celebrated his birthday at the Doherty Hotel in Clare Sunday.

Sr. Marie Alexander spent the weekend with relatives around Beal City.

Mrs. Suzanne Boven of Lansing called on Mr. and Mrs. Walter Rau, Anne Smith and Delores Gould, Thursday afternoon.

Confirmation rites took place Friday evening at St. Joseph's Church here. Fifty-two students were confirmed.

Mr. and Mrs. Ray Gross celebrated their 25th wedding anniversary Sunday, with friends and relatives as guests.

Mr. and Mrs. Herb Yuncker celebrated their 50th wedding anniversary Saturday evening. There was a very nice turnout.

Mr. and Mrs. Paul Smith and family visited Irene Smith over the weekend.

The Sixth Graders' "Cheerful Givers" played basketball against their parents Sunday afternoon. The Cheerful Givers won.

Jute Bierschbach entertained company Sunday.

Mr. and Mrs. Al Tilmann called on Mr. and Mrs. Jack Pung Sunday.

The K. of C. euchre tournament was held Saturday evening. Carl Mayes won first prize for the most games. The Beal City Bar and the Idle Hour Bar held their euchre party Sunday afternoon at the Idle Hour Bar in Weidman.

Mr. and Mrs. Doug Gruss are the proud parents of a baby boy.

Mr. and Mrs. Fred Gould called on Mr. and Mrs. Don Gould Wednesday evening.

Al and Patty Daniele of Chicago are the proud parents of a baby boy, born last Tuesday morning. Patty is the daughter of the former Anne Schafer and Laverne (deceased) of Beal City.

Pete Bierschbach, son of Mr. and Mrs. Jim Bierschbach, is home from the Army, on leave.

Mrs. Irene Schmidt called on Mrs. Emily Goffnett one day last week.

Mrs. Wendell Simmer called on Mrs. Walter Elias Monday.

Howard Martin of Mt. Pleasant called on his father, William Martin, Sunday afternoon.

BEAL CITY TO HAVE ITS OWN PARK

Beal City will shortly enjoy its own area-benefited park, thanks to foresight of Beal City folks and some money left over from the Centennial celebration of recent years.

It will be a 10-acres tract, adjacent to the Knights of Columbus Hall; eight acres were bought by the Beal City Business Association, with two acres of parking space available around the K. C. Hall.

The Beal City Business Association has turned the whole project over now to the Centennial Park Committee, composed of energetic Beal City business people and area farmers, who will make all plans and expend all monies.

To further develop the park, a consignment sale is being held at the park site May 20. Word is that anyone with anything really usable and saleable is invited to take items over on consignment. It's a chance for anyone with something to sell, from farm machinery to household ap-

pliances to antiques and so on, to put their items on sale and realize something from them. It's designed for those with something to sell but not enough to warrant a public auction by individuals.

The eight acres of park land was purchased from Ed Faber. Further plans for the park will be reported as they are developed.

REPORT ON MARCH CARD PARTIES AT BEAL CITY

At the March 16 regular card party at Beal City, there were 17 tables of pepper at play.

Agnes Sheahan won first prize for the ladies, with Vera Bierschbach second and Irene Clare low.

Austin Dent won first for the men, with Walter Sanderson second and Alwyn Cluley low.

Luella Smith won the pepper prize. Leona Faber won the door prize.

At the March 30 party, there were 19 tables at play.

Gertrude Gross won first prize for the ladies, with Leah Scharrer second and Katie Schumacher low.

Isadore Schafer won first for the men, with Clifton Anstey second and Julius Bierschbach low.

Bill Appelgreen won the pepper prize. Joe Lawens won the door prize.

The players received and heard read an Easter card from Ella Tilmann at the Medical Facility in

Mt. Pleasant.

The next card party at the K. C. Hall in Beal City will be this Thursday afternoon, April 13. Everyone is cordially invited to attend.

---0---

North Weidman

Elvah Gott, Reporter

Mr. and Mrs. Rusty Alwood have a new baby boy, born April 7. He weighed nine pounds, 12 ounces, and has been named Matthew James.

Helen Alwood and granddaughter, Heather, and I spent an afternoon in Mt. Pleasant recently. We had dinner at the Sweet Onion, then Helen saw her dentist. We also did some shopping.

Mrs. Carol Abbott and Robert and Mrs. Muriel Miller and Debbie called on their father, James Kennedy, at Rosebush Sunday after church.

Marlene Davy called on me one day last week. Wanda Graham and Connie Bushre also visited me, and had pie and coffee with me. Mr. and Mrs. Albert Gott took me out for evening dinner a week ago Sunday. Violet Carr spent Saturday afternoon with me.

---0---

Ten years ago today, the high temperature was 76 and the low, 55.

FISH FRY

Friday, APRIL 14



Adults 3⁵⁰

Children \$2⁰⁰

TAKE-OUT DINNERS AVAILABLE under 12

Weidman School

5³⁰ 7³⁰ p.m.

FAMILY STYLE ALL YOU CAN EAT!



THE LIONS CLUB FISH FRIES ARE FAMOUS ALL OVER

CENTRAL MICHIGAN. JOIN THE CROWD (YOU WON'T BE CROWDED) AND HAVE A WONDERFUL TIME!

Sponsored By Weidman Lions Club

LAKE ISABELLA

Helen Klenk, Reporter

Mr. and Mrs. Otto Yabs arrived home Sunday afternoon, after spending a week in Lansing, to welcome her sister, Faye, home from her winter's stay in California and Oregon. While we had snow, she witnessed the mud slides in California. While they were in Lansing, the Yabs visited many friends, and their son, his wife and children, at DeWitt. Saturday they attended a WWI pot-luck dinner and movie.

The party April 1, to kick off the 1978 golfing season, was a big success. It was great to see all our golfing buddies, some of whom we hadn't seen since last summer. Maxfield's prime rib dinner was delicious, as usual, and later we enjoyed dancing to the country-western music of The Travelers. Among those doing the light fantastic were Leo and Vada Gatehouse, who were also celebrating their 44th wedding anniversary. Happy Anniversary to a very nice couple!

Starting April 8, there will be a husband and wife golf event each Saturday at 4 p. m. This should be especially interesting to the weekend residents. Also, as he has done in past years, Warren Stanchina is offering free golf instruction every Saturday in May at 10 a. m., starting May 6. This is a great opportunity for beginners, and even some old pros could pick up a few pointers.

Seems as if winter has given way to spring, and it is a welcome change to see water in the lake instead of ice and snow.

Almost simultaneously with the water came the ducks and the killdeers, which are noisily checking shorelines for nesting places. Finally, a large flock of honking geese flew over the lake and removed all doubts about spring being here.

Kay and Herb Serum of Crown Pointe Drive arrived home last Monday, after spending three weeks with their son and family in California.

Don't forget the last fish fry of the season, at the Weidman School Friday, April 14, sponsored by the Weidman Lions Club.

Lake Isabella Property Owners have purchased a very large weed harvester for getting weeds out of the lake. Formerly the chemical 2-4-D was used, but from now on there will be no more chemicals in the lake. The big machine cost \$54,000, and cuts weeds to any depth and loads the harvest on a barge.

The Owners Association also spent considerable amounts last year with Aquatic Systems, Inc., of Ludington, for study of water pollution, chemistry, fisheries,

etc. The Association has minnows now in golf course ponds, which will be dumped into the lake for fish food.

The lake got its weed contamination some years back when the dam at Barryton, on the Chippewa River, went out and washed debris and weeds downstream.

Around Horr

Jessie Rosencrantz, Reporter

Mr. and Mrs. Garth Lawrence and Pam were a week ago Sunday guests of his mother, Mrs. Nettie Lawrence. Mr. and Mrs. Lawrence Graber were Sunday dinner guests of Mrs. Lawrence.

Mr. and Mrs. Mack Denslow entertained 14 of their children and grandchildren at dinner Sunday.

Mr. and Mrs. Elton Bellows spent Thursday evening with the Elwood Millers.

Elwood and Iola called at the Glenwood Holmes home at Lake Sunday afternoon. They called on his mother at Big Rapids last Wednesday.

Guests for the weekend at the Pete Wood home were Dale Bywater and son, Pat, Mack and Steve Aldrich, Wilbur Wright, Mr. and Mrs. Eric Bingham and children, and Mr. and Mrs. Dan Mills and Carrie, Jack Lynch, Mr. and Mrs. Mike Wood, and D. J. Whitman, who spent the weekend with them.

Mr. and Mrs. Anthony Grech were Tuesday callers of the Charles Fahnestocks. Rev. and Mrs. Athel Lynch were Saturday callers. Mrs. Mary Fahnestock and Mrs. Frances Fahnestock were Sunday afternoon callers.

Bill Thompson participated in music for a "sock hop" in St. Louis Saturday evening.

Mrs. Betty Thompson attended a UMW meeting at the home of Mrs. Lucille Fountain last Wednesday afternoon.

Mr. and Mrs. Ervin Dutcher, Jr., and Steve traveled to Florida in their mobile home recently, for a week's outing in the sun. They returned last week. They visited Don Harshman at Bradenton.

Monroe Beckwith spent Saturday over night with Ervin and Ronna Jean Dutcher. Sandra and Ed Oplinger were Sunday dinner guests. Ervin, Sr., and Goldie called Saturday evening.

A GIRL FOR THE

PAUL SIMMERS, JR.

Born to Mr. and Mrs. Paul Simmer, Jr., a girl, April 12, in the hospital at Mt. Pleasant.

The little Miss weighed six pounds, three ounces, and has been named Heather Dawn.

Jodi and Baby Heather returned to their new home in Gladwin Saturday. Paul has a new job there, with the DNR. The young

couple have a nice cottage there to take their new baby home to.

Mr. and Mrs. Mitchell McArthur have returned from a two week's vacation in North Carolina, where Mitch enjoyed golfing. Mr. and Mrs. Stuart McArthur joined them for the weekend. On their return trip Mitch

and Jean visited at the home of her brother, Robert Showalter, and wife, in Martinville, Va.

Mr. and Mrs. Ron Apple and son and Mr. and Mrs. Bernard Pitts were Sunday guests of Mr. and Mrs. Paul Barbour, in Grand Ledge.

Don't forget the Lions Club fish fry this Friday evening, here.

OUR BIGGEST SPREADERS ARE BIG TIME SAVERS

NEW IDEA 8½-TON SPREADER

This is a "big" spreader built to take the tremendous punishment of hauling huge loads. It's a real heavyweight... built to handle 8½ tons per trip. Pull it on rugged bogie axles or mount it on a truck chassis. It has all the quality features you need for spreading time-saving big loads.

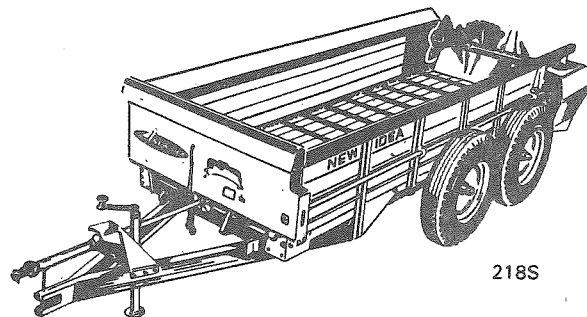

218S

\$000000

NEW IDEA 10-TON SPREADER

This giant has it all. It has all the heavyweight features it takes to handle 10 tons of manure. The conveyor chain has an exclusive "overload protection system" that automatically disconnects, then instantly resets itself so you don't have to leave the tractor seat. Options include a hydraulic endgate or pan attachment for sloppy loads, also an upper beater to level out those heaped loads.

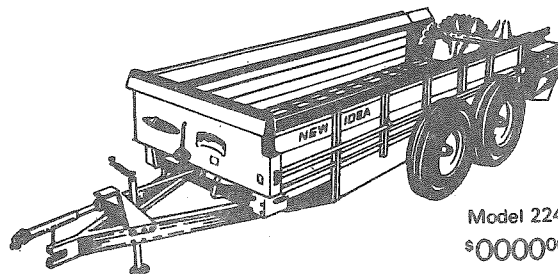

Model 224S

\$000000

NEW IDEA
FARM EQUIPMENT

where the whole idea means better performance

TILMANN HARDWARE
BEAL CITY, MICH.
PHONE (517) 644-2252

Lakeview High relies on 3 R's to be among the best in U.S.

The Lakeview Schools, from kindergarten through Grade 12, got a great play in the Detroit Free Press April 7, occupying the top of the front page and continuing inside with nearly a half-page of interesting data on the Lakeview philosophy of teaching kids.

Lakeview High is one of two Michigan schools that have been named in honors for maintaining extremely high scores on the national Scholastic Aptitude Tests, while nationally schools are dropping ker-plunk! on scholastic achievements.

Lakeview teachers and administrators say that they have steadfastly continued to teach "the basics" first and foremost, and to drill them into kids' heads beginning in the first grades at school.

Another interesting aspect of the Lakeview situation is the connotation by teachers, school officials and townspeople, that the school is intimately a part of the town's life.

It was stated that a "teacher-parent conference" might well take place in a food-store aisle as in a classroom.

The town uses the school buildings every day in the week, including evenings, "for everything from receptions to family reunions."

We congratulate Lakeview on its schools and its kids' SAT ratings. Only one other school in Michigan could compare to Lakeview, and that is Detroit Country Day, a private school.

Maybe someday we'll all get back to teaching "basics" before baloney.

---0---

NEWS NOTES

Mrs. James Noe is in the Alma Hospital, after suffering a broken hip in a fall at a rest home in St. Louis.

Carolyn Tibbetts of Alma College was a Friday supper guest of her mother, Mrs. Claribel Beutler. Mr. and Mrs. Carl Beutler and Brenda were callers.

There's an old superstition that the weather on Easter Sunday will determine the weather for the next seven Sundays. Easter this year (March 26) was cold and rainy. We've had two rainy and cold Sundays since. Wonder what it'll be like the next five Sundays?

HOME PAPER FOR THE WEST HALF OF ISABELLA COUNTY

In the Editor's Mail

Dear Connie,

Thanks for sending the paper, even if I failed to send the money on time!

I enjoyed seeing so many Weidman and former Weidman folks here this winter.

Have a nice vacation!

Ercel Woodward
Zephyrhills, Fla.

(Thanks, Ercel, I sure did have a nice vacation this time--for a change!)

---0---

In uniform

Benjamin F. Loomis, 19, son of Mr. and Mrs. Virgil Loomis of 4870 S. Meridian Road, has enlisted in the U. S. Air Force's delayed enlistment program.

According to Master Sergeant Marty Ragnone, Air Force recruiter at Mt. Pleasant, his entry into the DEP serves two purposes. First, it allows the Air Force to schedule an opening for him to attend basic training and be assigned to a job or skill area. And the DEP enables Ben, a 1978 graduate of Mt. Pleasant High School, to wrap up his personal affairs before leaving home.

Benjamin will enter the regular Air Force June 26, following graduation from a six-weeks basic training course at Lackland Air Force Base at San Antonio, Texas.

He will receive technical training in the mechanics aptitude area, and be assigned to an Air Force unit duty station.

---0---

MT. PLEASANT OFFICE STARTS STAMP CLUB

Larry Fussman, Superintendent of Postal Operations of the Mt. Pleasant Post Office, announces that he has been appointed as project leader in the central Michigan area for the Benjamin Franklin Stamp Club, a new project of the U.S. Postal Service.

Larry Fussman will contact all schools in the area and in the program, and offer data and in-

SIX CANDIDATES FOR CHIP HILLS BOARD OF EDUCATION

Six candidates will run for two seats on the Chippewa Hills Board of Education in the June 12 election. They are:

Charlene Boer of Mecosta, Neal Brower and Alan Pitts of Barryton, and James Damitio and Dean Den-slow of Weidman.

William Baldwin and Marlys Wager are not seeking re-election.

---0---

Mrs. Gary Wernette underwent major surgery at CMC Hospital Monday of this week.

formation.

He has a film strip on the educational value of stamp collecting. He also will offer suggestions on collecting stamps at no cost, or inexpensive methods of stamp collecting. He will work with teachers in interesting students to form stamp clubs.

He is available at the Mt. Pleasant post office, tel. 773-3653.

---0---

'Monday evening's tornado watch warning was this season's first such event, weatherwise. Tuesday's skies were a bit weird, as black clouds came and went.

LOU FIORILLO
Pharmacist
Phone 644-2511

Weidman
REXALL
Pharmacy

Friday till 8 p. m.
Closed Sundays
And Holidays

Tilmann Hardware

BEAL CITY

Hardware and Farm Implements

PAPEC AND NEW IDEA MACHINERY

Post Office Mt. Pleasant R. 1

Phone 644-2252, Weidman

GIFTS
Packaged Liquor
Beer & Wine
Take Out
Small Groceries
Food Stamps
Accepted Here

BUDS
Party Store

OPEN
SEVEN
DAYS
A WEEK
Ph. 644-3500

WEIDMAN

AMERICAN GREETING CARDS

STRAUS PROCESSING CO.

Dependable Custom Butchering. Processing of Beef, Pork, proper aging, cooling, curing, we sell meat wholesale and retail. Butchering days: Wednesdays and Thursdays.
4 miles north of Beal City
Phone 644-2292



McArthur Insurance Agency
"WE INSURE EVERYTHING"

LIFE

WEIDMAN
Phone 644-3465



WEAVER'S

VILLAGE INN

WEIDMAN

BEER IN OR OUT--MIXED DRINKS
SANDWICHES--PIZZA To Take Out
9 to 2 a. m.

Crittenden

Funeral Home

Phone 967-3464, Remus



BEAL CITY BORON

GAS AND OIL
Phone 644-2142
BORON DISTRIBUTOR

A COMPLETE LINE OF DEPENDABLE PRODUCTS
FOR THE FARM & HOME

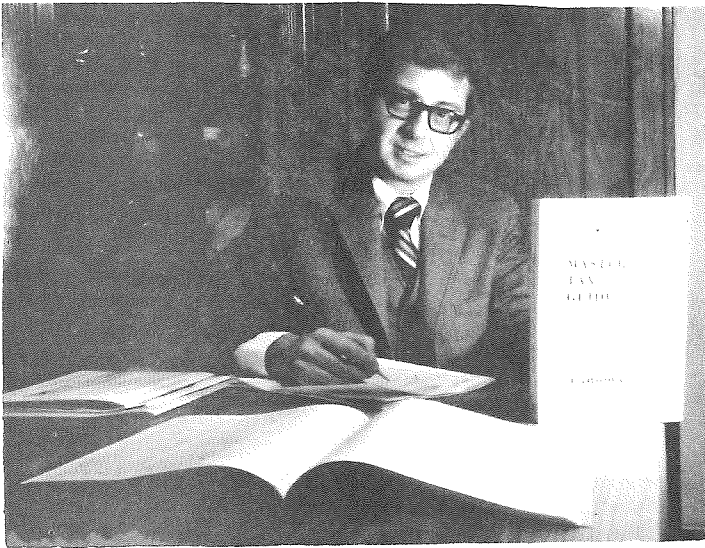

GEORGE MILLER STEPS ON UP--From Dean of Finance at Mid Michigan Community College at Harrison, to Community College Fiscal Analyst, by appointment of the State Senate Appropriations Committee. Above photo was taken soon after George graduated from Ferris State College with a Bachelor of Science degree and was doing income-tax work in this area. Since then he has spent seven years as Dean of Finance at Mid Michigan Community College. It's a big step up for George, and his many friends offer congratulations. Messenger photo

In his new appointment, George will be responsible for liaison between the 29 community colleges in Michigan and the State Senate, which appropriates approximately \$125,000,000 per year for operations of the community colleges.

He will meet with Boards of Trustees and presidents of the 29 community colleges, and determine specific problems of education there, and how the state should become involved in those problems.

"There are bound to be financial problems in all schools," he said in an interview this week, "because of declining or stabilizing numbers of students coming out of high schools."

His responsibilities this year will be concerned only with community colleges and private schools entirely, he said, but he will also be involved in the problems of taking community service programs and moving them into the academic cate-

gory, i.e., the liberal arts and sciences, vocational and technical programs, and the health sciences.

He will begin work in Lansing the last week in May, and will live in East Lansing, where he plans to finish his Master's Degree work at MSU. He goes to Denver, Colo., May 8, to meet with community college liaisons all through the United States and compare their operations with those in the Michigan community colleges.

His appointment officially took place a week ago, though the job has been in the offing since last fall, delayed due to illnesses of two members of the Senate Appropriations Committee. Technically, he will work under the agency of the Senate Fiscal Agency.

He has been at Mid Michigan Community College seven years, during which time that college has risen from financial chaos to

high-ranking fiscal and curricula ranking.

Because of his absence, Mid Michigan Community College underwent quite a thorough administrative renovation, since George's financial management office had to be taken over by some other person or branch of the college administration.

During his three-week vacation George says he plans to do some fishing with his father, Elwood Miller, "just around this area," and otherwise relax and get ready for quite a big step up.

---0---

BIRTHDAY PARTY FOR EMMA MIDDLESWORTH

A group of relatives and friends gathered at the Coldwater Lake Inn April 2, for dinner

celebrating the 86th birthday of Mrs. Emma Middlesworth.

Among those present were Wayne and Joan Charnes, Jim Cole and son-in-law and daughter, Bob and Colleen, Al Brown and wife of Saginaw, Evart and Myrtle Bowerman, Jo Alkofer of Barryton, and K.C. Charnes and Vivian Kiles, Jack Trainor of Rosebush, and Fred and Mary Cole of Midland.

After dinner the party went to the Charnes home, and were joined by Marie Smith, Edna Bowein and Claribel Beutler, for ice cream and cake.

Congratulations on your birthday, Emma!

BETTER THAN A LETTER

FARM AND GARDEN SUPPLIES

SEEDS

- Seed Oats Certified or Year-Away Corwood and Mariner

BULK FERTILIZER

Alfalfa & Clover Seed

- Bulk & Packaged Garden Seeds
- Lawn Grass Seed

Onion Sets, Seed Potatoes

BADER MILLING CO.

YOUR COMPLETE FARM SERVICE

WEIDMAN

Tel. 644-3300
644-2322

NOTICE CHANGE OF HOURS

THE WEIDMAN PHARMACY--Now opens at 8 o'clock in the morning.

Hours will be from 8 to 6 Monday through Saturday, and 8 to 8 o'clock on Friday.

COLD BEER, WINE AND POP--To take out.

WEIDMAN PHARMACY

LOU FIORILLO, Pharmacist

Ph. 644-2511

Baumann's I.G.A.

ROSEBUSH-WEIDMAN



AT BOTH STORES, Weidman and Rosebush.



FIRST PRIZE--Trip to California: Disneyland, Knott's Berry Farm, Universal Studios, Movieland Museum, and much more!

FIVE Runner-Up trips, one full day at Cedar Point.

Drop Your Check-out Tab in the Slot Designated for the Boy or Girl of Your Choice. Contest Now On!